

Mounting Brackets

SECURELY SEAT RACK MOUNTED POWER DISTRIBUTION DEVICES

Raritan Mounting Brackets are built to ease the installation and secure Raritan power distribution products into racks, IT cabinets, and other structures. Compatible with Raritan rack PDUs, inline meters, transfer switches, smart rack controllers, and branch circuit monitoring systems, these Mounting Brackets can be used vertically or horizontally to increase mounting flexibility and solve instrumentation challenges.

BRACKETS OPTIONS INCLUDE

- L or Angle Mounting Brackets join two parts at a 90-degree angle, providing more consistent straight corners to support both vertical and horizontal mounting positions.
- Hinge Mounting Brackets combine two parts at various and adjustable angles/pitches to support vertical and horizontal mounting positions.
- Vertical Mounting Brackets are molded into either a Flat, S-shape, or U-shape to support varied vertical mounting positions.
- Specialized Mounting Brackets are molded to resolve specific mounting scenarios.

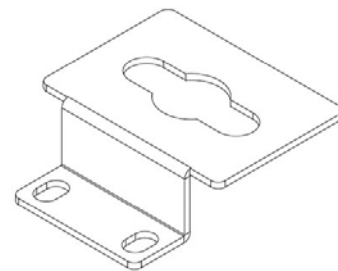

Benefits

- Versatile for use in racks, IT cabinets, and other structures.
- Bracket options support vertical and horizontal mounting positions.
- Constructed of heavy steel to ensure strength and durability.
- Meets ROHS Directives material restrictions.
- Molded into various shapes to address common mounting and instrumentation challenges.
- Designed with functional holes to ease tool-less button mounting and secure screws.

L OR ANGLE MOUNTING BRACKETS

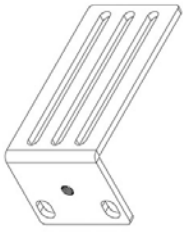

250-70-0094-00

Dimensions (WxDxH):
930mm x 436mm x 38mm

Extended width L Bracket with small-sized U-shaped and extended length U-shaped holes to mount 0U PDUs.

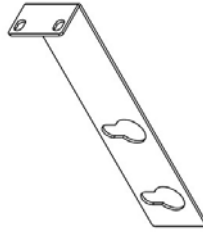

250-80-0021-00

Dimensions (WxDxH):
210mm x 436mm x 30mm

Extended width L Bracket with keyhole and small-sized U-shaped holes to mount two 0U PDUs side-by-side.

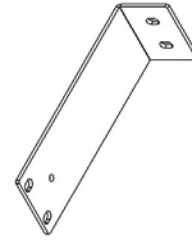

250-80-0040-00

Dimensions (WxDxH):
175mm x 43mm x 52mm

Extended width L Bracket with rounded holes to mount 0U PDUs.

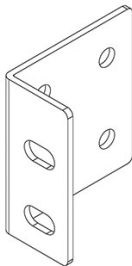

250-80-0046-00

Dimensions (WxDxH):
52.2mm x 25.5mm x 48.8mm

L Bracket with rounded and small-sized U-shaped holes to mount a PDU with outlets facing inward or outward.

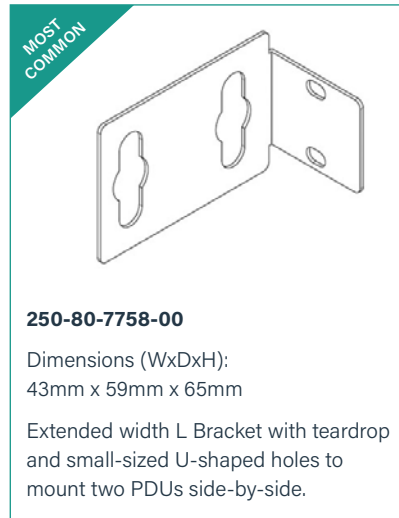

250-80-7758-00

Dimensions (WxDxH):
43mm x 59mm x 65mm

Extended width L Bracket with teardrop and small-sized U-shaped holes to mount two PDUs side-by-side.

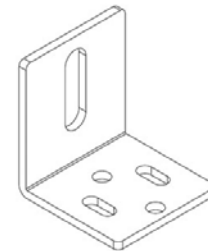

251-01-0034-00

Dimensions (WxDxH):
50mm x 43mm x 43mm

L Bracket with rounded, small-sized U-shaped, and extended length U-shaped holes to mount 0U PDUs.



251-01-0036-00

Dimensions (WxDxH):
88mm x 59mm x 30mm

L Bracket with square, teardrop, rounded, and small-sized U-shaped holes to mount 0U PDUs facing the side of a cabinet.

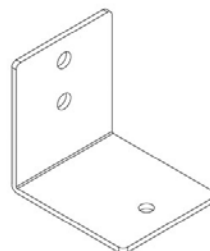

251-01-0039-00

Dimensions (WxDxH):
486mm x 44mm x 10mm

L Bracket with rounded holes to mount 0U PDUs.

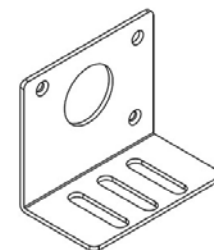

251-01-0055-00

Dimensions (WxDxH):
60mm x 40mm x 70mm

L Bracket with rounded and extended length U-shaped holes to mount 0U PDUs.

L OR ANGLE MOUNTING BRACKETS

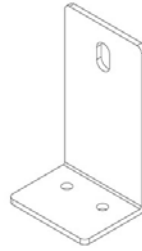

251-01-0102-00

Dimensions (WxDxH):
93mm x 40mm x 50mm

L Bracket with rounded and small-sized U-shaped holes to extend the height of a PDU.

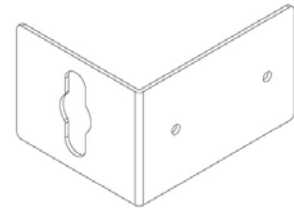

251-01-0104-00

Dimensions (WxDxH):
95mm x 75mm x 60mm

L Bracket with rounded and extended length U-shaped holes to mount a single PDU.

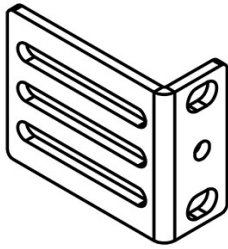

251-02-0011-00

Dimensions (WxDxH):
53.2mm x 43.6mm x 21.3mm

L Bracket with rounded, small-sized U-shaped and extended length U-shaped holes to extend the height of a PDU.

HINGE MOUNTING BRACKETS

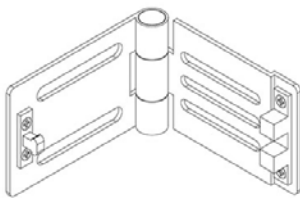

251-01-0054-00

Dimensions (WxDxH):
83.4mm x 68.2mm x 53.6mm

Hinge Bracket with squared and extended length U-shaped holes to mount a single PDU.

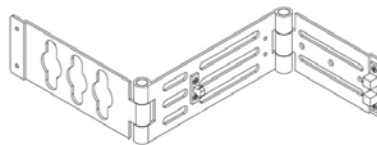

251-01-0068-00

Dimensions (WxDxH):
108.2mm x 159.5mm x 142.5mm

Hinge Bracket with two hinge joints and teardrop, small-sized U-shaped, and extended length U-shaped holes to mount a single PDU.

VERTICAL MOUNTING BRACKETS

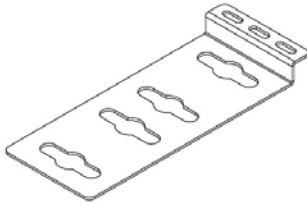

250-75-0006-00

Dimensions (WxDxH):
208mm x 81mm x 18mm

Extended width S-shaped Vertical Bracket with teardrop and small-sized U-shaped holes to mount two 0U PDUs side-by-side.

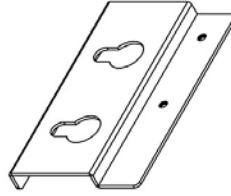

250-80-0012-00

Dimensions (WxDxH):
142mm x 88mm x 14.6mm

U-shaped Vertical Side-by-Side Bracket with rounded and teardrop holes to mount two 0U PDUs side-by-side.

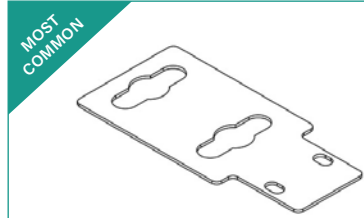

250-80-0049-00

Dimensions (WxDxH):
136.5mm x 65mm x 1.6mm

Flat Vertical Bracket with teardrop and small-sized U-shaped holes to mount 0U PDUs.

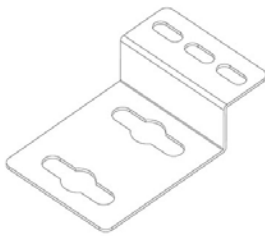

251-01-0018-00

Dimensions (WxDxH):
131.3mm x 81mm x 35mm

S-shaped Vertical Bracket with teardrop and small-sized U-shaped holes to mount two 0U PDUs side-by-side.

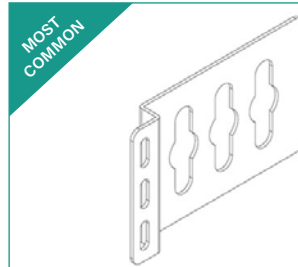

251-01-0021-00

Dimensions (WxDxH):
131.3mm x 81mm x 14.7mm

S-shaped Vertical Bracket with teardrop and small-sized U-shaped holes to mount two PDUs side-by-side.

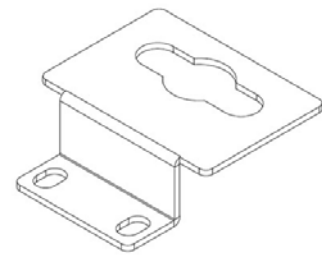

251-01-0025-00

Dimensions (WxDxH):
66mm x 64mm x 22mm

S-shaped Vertical Bracket that occupies 1U of EIA mounting space with teardrop and small-sized U-shaped holes.

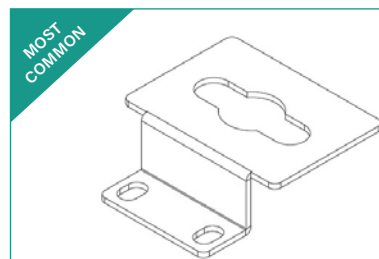

251-01-0026-00

Dimensions (WxDxH):
66mm x 64mm x 22mm

S-shaped Vertical Bracket that occupies 1U of EIA* mounting space with teardrop and small-sized U-shaped holes.

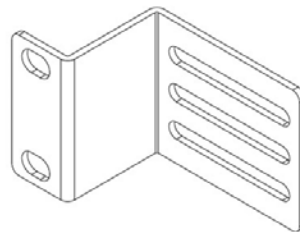

251-01-0028-00

Dimensions (WxDxH):
53.2mm x 34mm x 20mm

S-shaped Vertical Bracket with small-sized U-shaped and extended length U-shaped holes to mount 0U PDUs with outlets facing inward or outward.

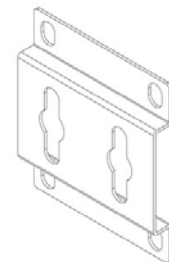

251-01-0029-00

Dimensions (WxDxH):
125.3mm x 110mm x 15mm

U-shaped Vertical Side-by-Side Bracket with rounded and teardrop holes to mount two 0U PDUs side-by-side.

*Electronic Components Industry Association, EIA Standards Committee

VERTICAL MOUNTING BRACKETS

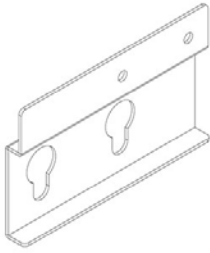

251-01-0032-00

Dimensions (WxDxH):
142mm x 12mm x 88mm

U-shaped Vertical Side-by-Side Bracket with keyhole and rounded holes to mount two 0U PDUs side-by-side.



251-01-0070-00

Dimensions (WxDxH):
131.3mm x 19mm x 81mm

S-shaped Vertical Bracket with extended length U-shaped and teardrop holes to mount two 0U PDUs side-by-side.



251-01-0092-00

Dimensions (WxDxH):
244.5mm x 43.6mm x 2mm

Flat Vertical Side-by-Side Bracket with rounded and extended length U-shaped holes.

SPECIALIZED MOUNTING BRACKETS

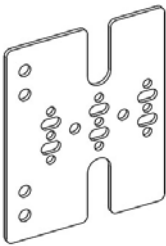

251-01-0086-00

Dimensions (WxDxH):
100mm x 2mm x 82mm

Specialized flat bracket with rounded and small-sized U-shaped holes to mount PDUs in Legrand's Minkels Varicon-M cabinets.

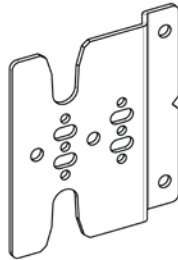

A0026-000001-000-1

Dimensions (WxDxH):
78.31mm x 9.9mm x 86.9mm

Specialized Bracket with rounded and small-sized U-shaped holes to mount PDUs in Legrand's Nexpan cabinets.

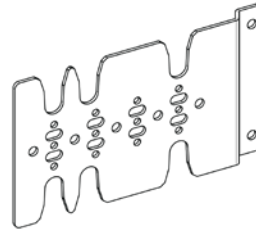

A0026-000002-000-1

Dimensions (WxDxH): 153.31mm x 9.9mm x 86.9mm

Specialized Bracket with rounded and small-sized U-shaped holes to mount PDUs in Legrand's Nexpan cabinets.

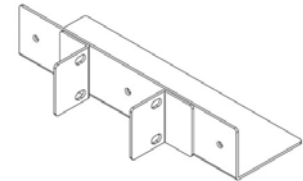

251-02-0023-00

Dimensions (WxDxH):
225mm x 68.7mm x 45.8mm

Specialized two-post bracket for mounting shallow rack transfer switches.

MOUNTING BRACKET KITS

G2-RACK-FOR-ZU

Bracket Kit used to mount 0U PDUs.

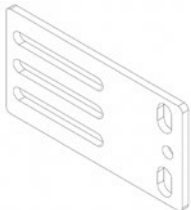

Flat Vertical Bracket
(250-70-0007-00)

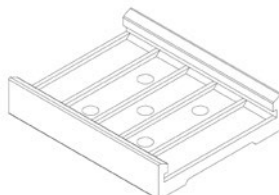

Sliding Bracket
(252-67-0029-00)

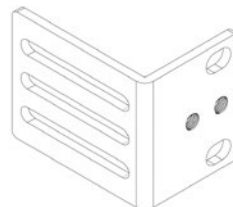

L Bracket
(250-70-0093-01)



Button Mount*
(250-80-0011-00)

*Button Mounts are made of high-strength plastic.

MOUNTING BRACKET KITS

G3-RACK-FOR-ZU

Bracket Kit used to mount 0U PDUs.

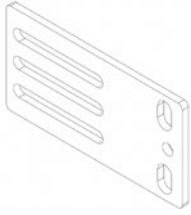

Flat Vertical Bracket
(250-70-0007-00)

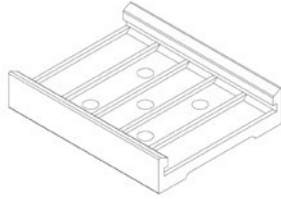

Sliding Bracket
(252-67-0029-00)

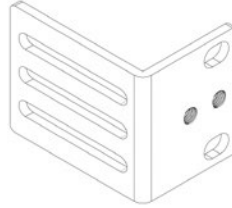

L Bracket
(250-70-0093-01)



Button Mount*
(250-80-0011-00)

RACK-FOR-ZU

Bracket Kit used to mount DPX-xxx and PX-xxx 0U PDUs.

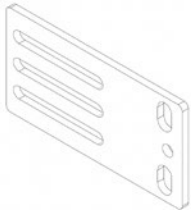

Flat Vertical Bracket
(250-70-0007-00)

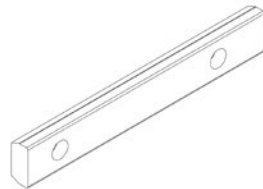

Pin Bracket
(250-80-0009-00)

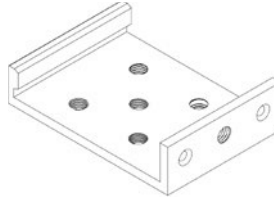

Sliding Bracket
(250-80-0008-00)

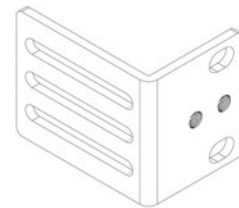

L Bracket
(250-70-0093-01)



Button Mount*
(250-80-0011-00)

RACK-KIT-DPX-1U

Bracket Kit used to mount 1U PDU in a 19" cabinet.

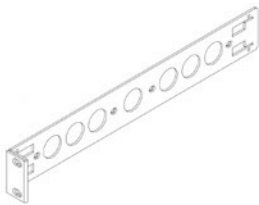

250-80-0123-00



250-80-0125-00

RACK-KIT-PX-2U

Bracket Kit used to mount 2U PDU in a 19" cabinet.

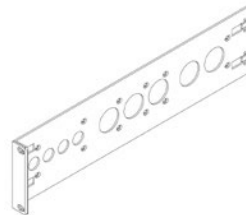

250-70-3017-00



250-70-3018-00

*Button Mounts are made of high-strength plastic.

Part Number	Type	Dimensions (W x D x H)
250-70-0094-00	L Bracket	930mm x 436mm x 38mm
250-80-0021-00	L Bracket	210mm x 436mm x 30mm
250-80-0040-00	L Bracket	175mm x 43mm x 52mm
250-80-0046-00	L Bracket	52.2mm x 25.5mm x 48.8mm
250-80-7758-00	L Bracket	43mm x 59mm x 65mm
251-01-0034-00	L Bracket	50mm x 43mm x 43mm
251-01-0036-00	L Bracket	88mm x 59mm x 30mm
251-01-0039-00	L Bracket	486mm x 44mm x 10mm
251-01-0055-00	L Bracket	60mm x 40mm x 70mm
251-01-0056-00	L Bracket	103mm x 38mm x 43.6mm
251-01-0102-00	L Bracket	93mm x 40mm x 50mm
251-01-0104-00	L Bracket	95mm x 75mm x 60mm
251-02-0011-00	L Bracket	53.2mm x 43.6mm x 21.3mm
251-01-0054-00	Hinge Bracket	83.4mm x 68.2mm x 53.6mm
251-01-0068-00	Hinge Bracket	108.2mm x 159.5mm x 142.5mm
250-75-0006-00	Vertical Bracket	208mm x 81mm x 18mm
250-80-0012-00	Vertical Bracket	142mm x 88mm x 14.6mm
250-80-0049-00	Vertical Bracket	136.5mm x 65mm x 1.6mm
251-01-0018-00	Vertical Bracket	131.3mm x 81mm x 35mm
251-01-0021-00	Vertical Bracket	131.3mm x 81mm x 14.7mm
251-01-0025-00	Vertical Bracket	66mm x 64mm x 22mm
251-01-0026-00	Vertical Bracket	66mm x 64mm x 22mm
251-01-0028-00	Vertical Bracket	53.2mm x 34mm x 20mm
251-01-0029-00	Vertical Bracket	125.3mm x 110mm x 15mm
251-01-0032-00	Vertical Bracket	142mm x 12mm x 88mm
251-01-0070-00	Vertical Bracket	131.3mm x 19mm x 81mm
251-01-0092-00	Vertical Bracket	244.5mm x 43.6mm x 2mm
251-01-0086-00	Specialized Bracket	100mm x 2mm x 82mm
A0026-000001-000-1	Specialized Bracket	78.31mm x 9.9mm x 86.9mm
A0026-000002-000-1	Specialized Bracket	153.31mm x 9.9mm x 86.9mm
251-02-0023-00	Specialized Bracket	225mm x 68.7mm x 45.8mm
G2-RACK-FOR-ZU	Bracket Kit	Various components included
G3-RACK-FOR-ZU	Bracket Kit	Various components included
RACK-FOR-ZU	Bracket Kit	Various components included
RACK-KIT-DPX-1U	Bracket Kit	Various components included
RACK-KIT-PX-2U	Bracket Kit	Various components included
RACK-KIT-PX3TS-1U	Bracket Kit	Various components included

Packaging Notes: One (1) mounting bracket is included per package unless a Mounting Bracket Kit is purchased where multiple bracket types are included. Bracket assembly screws are included, where necessary. Cage nuts are not included.